

Dimensions are approximate
Unit: mm

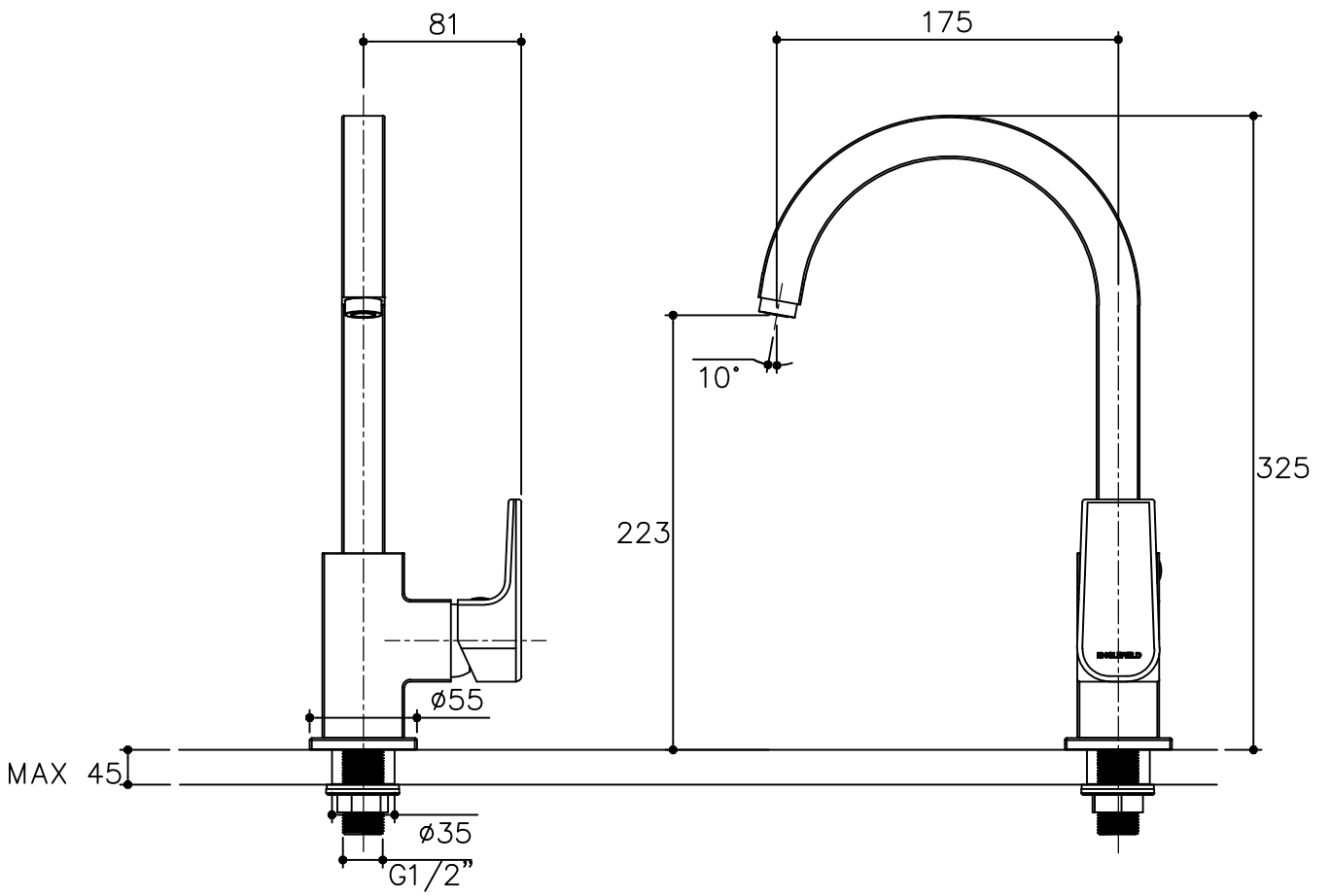

Product Diagram 98092X-4-CP