

Dimensions are approximate  
Unit: mm

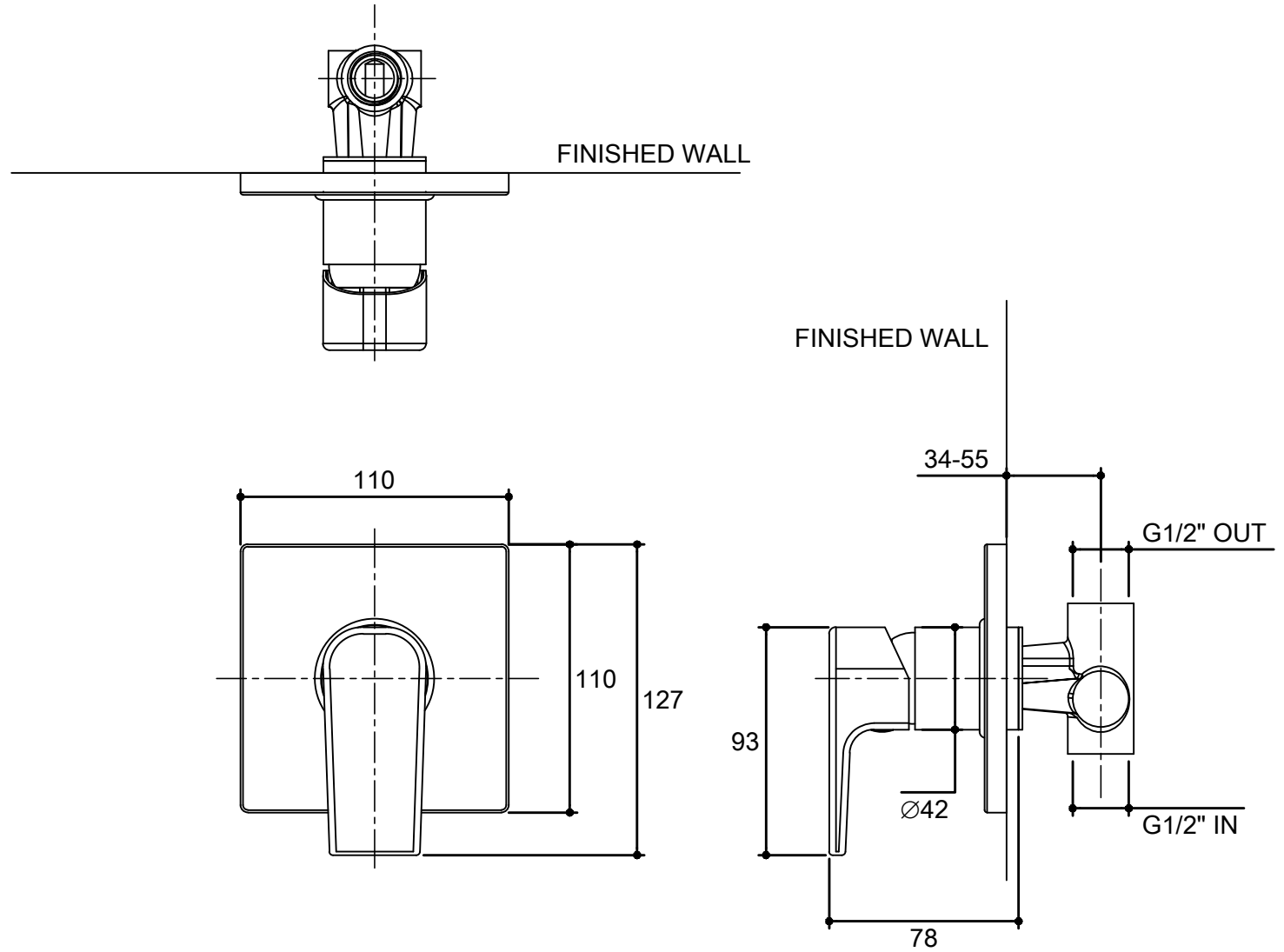

Product diagram 98090X-4-CP