

Dimensions are approximate  
Unit: mm

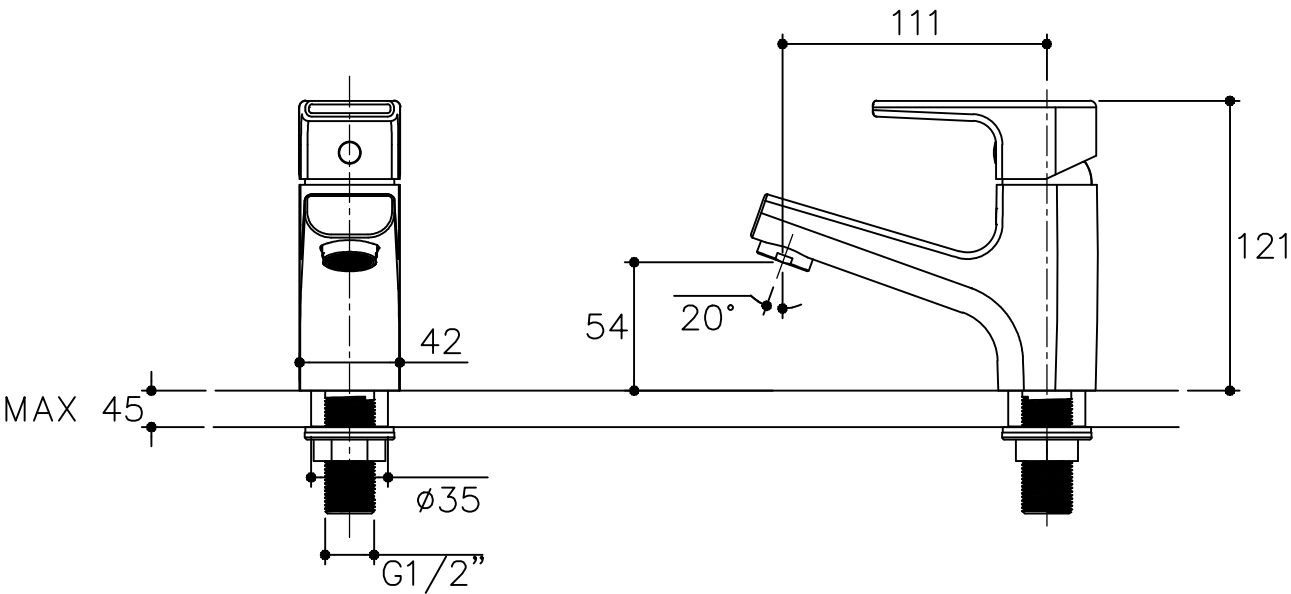

Product Diagram 98098X-4-CP